

1

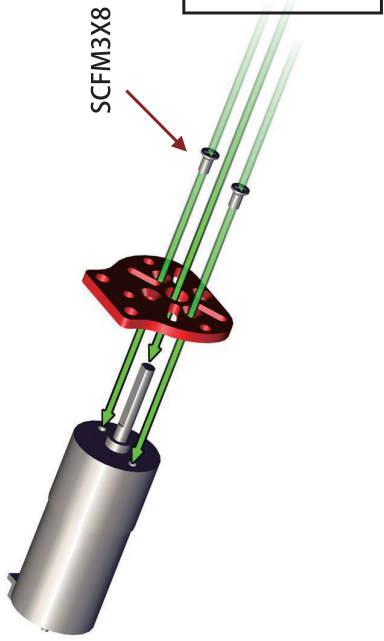

3

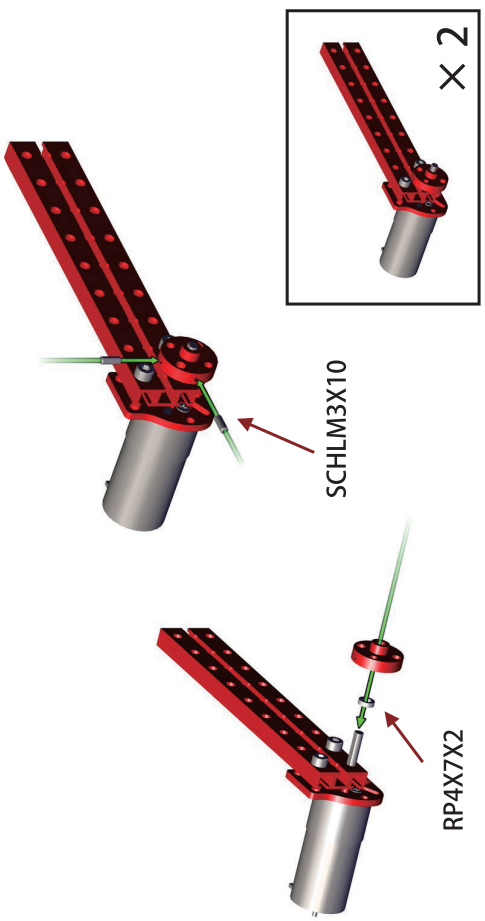
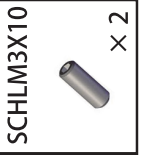
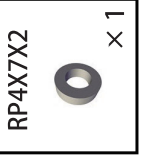
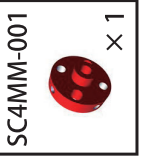

2

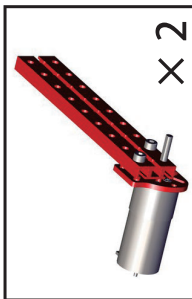
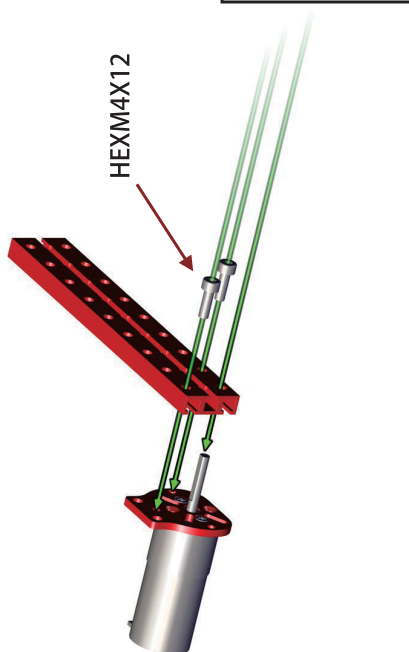
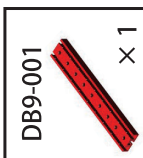

4

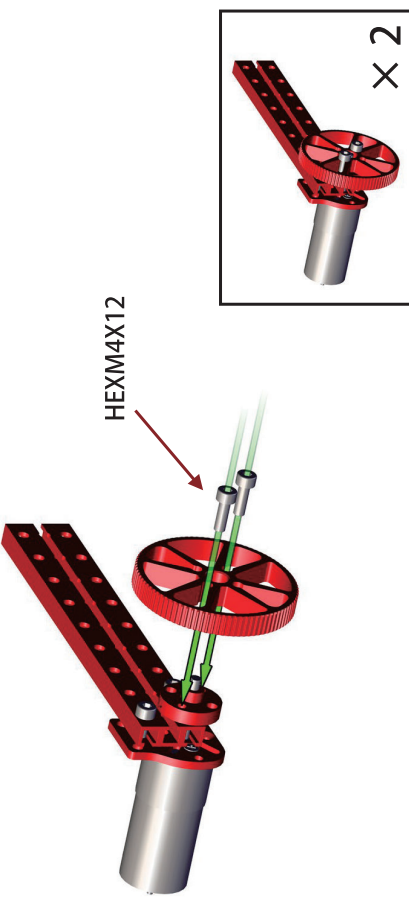
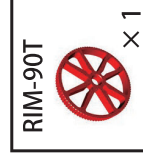

5

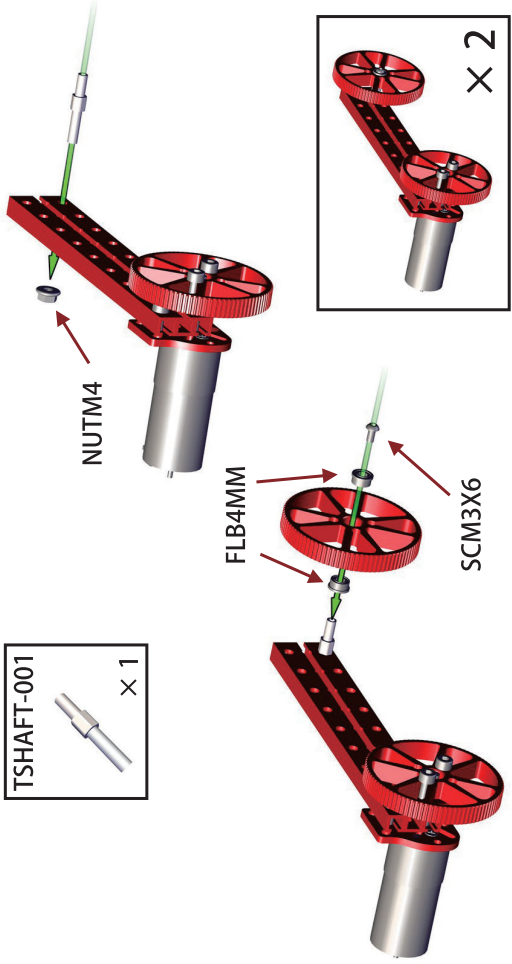
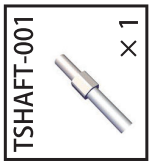
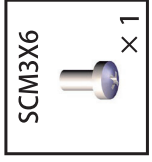
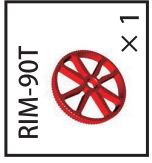
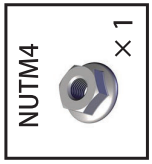

7

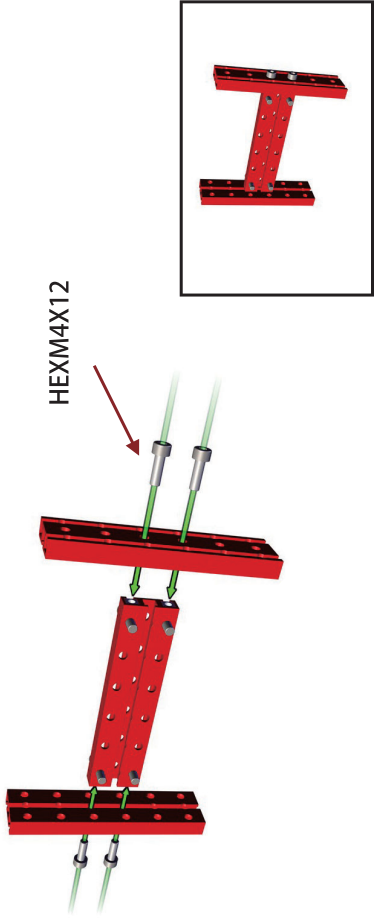
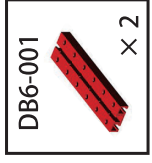

6

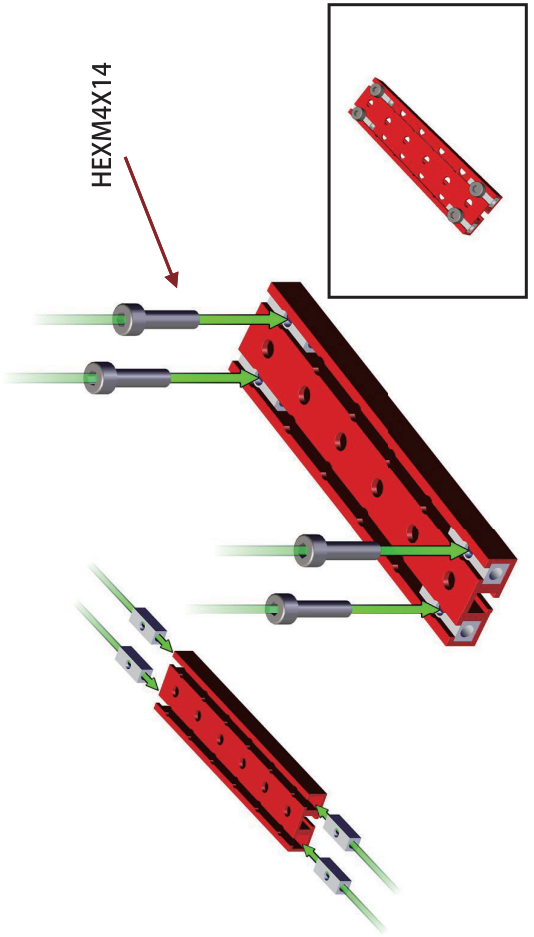
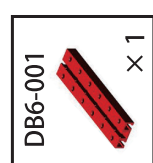
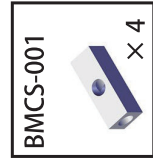

8

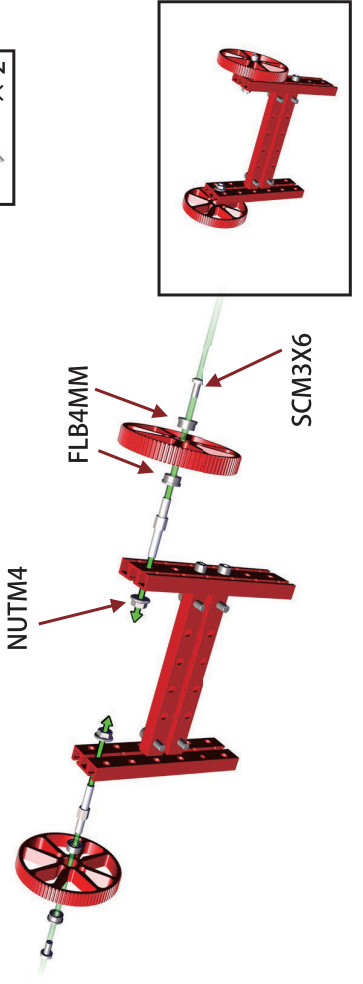
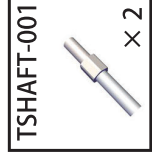
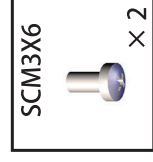
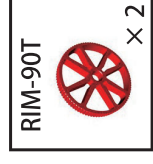
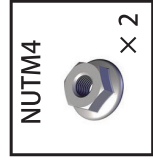

# 9

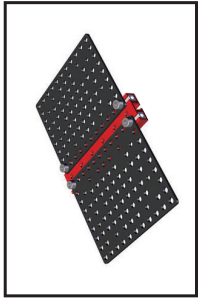
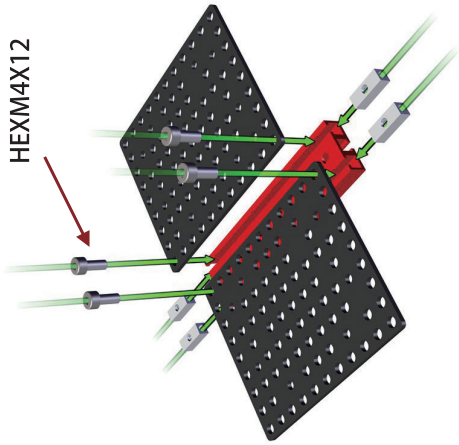
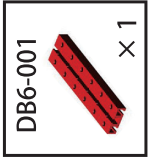
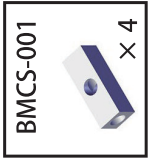
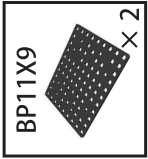

# 11

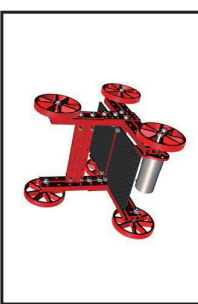
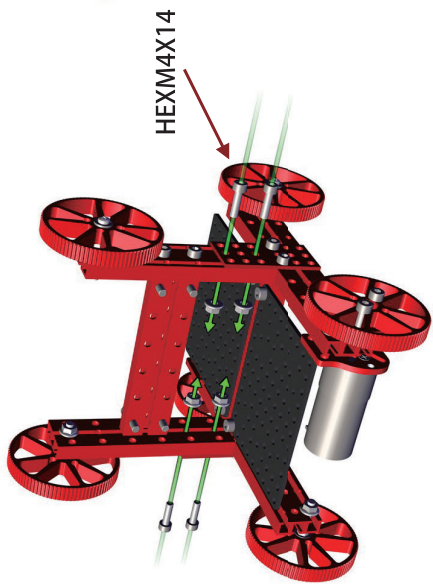
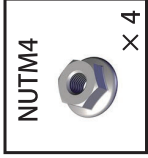

# 10

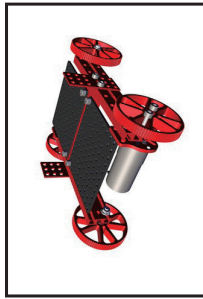
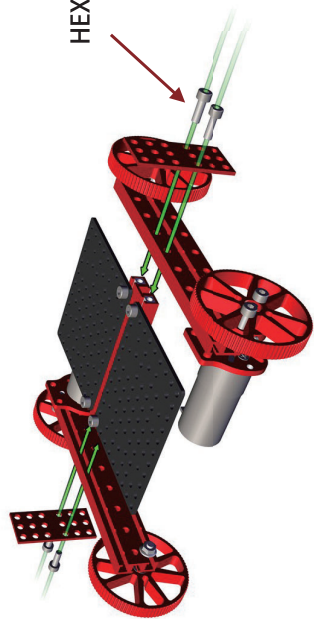
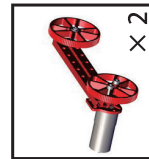
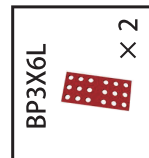
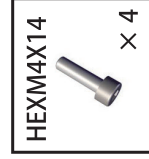

# 12

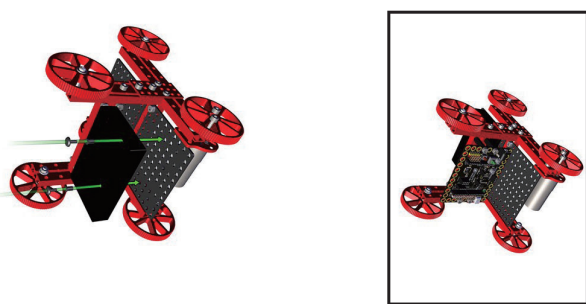
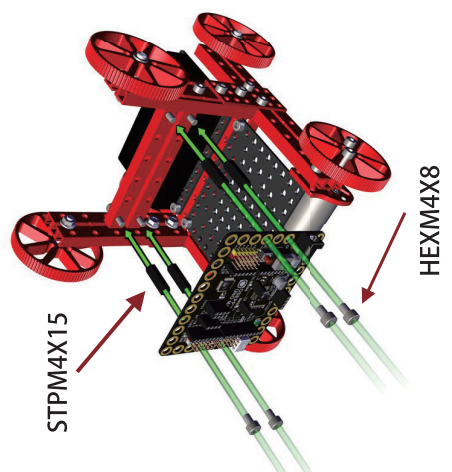
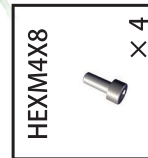
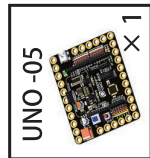



# 13

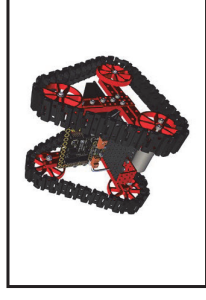
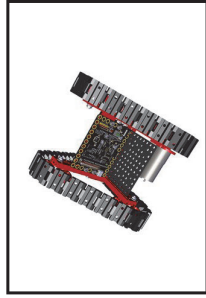
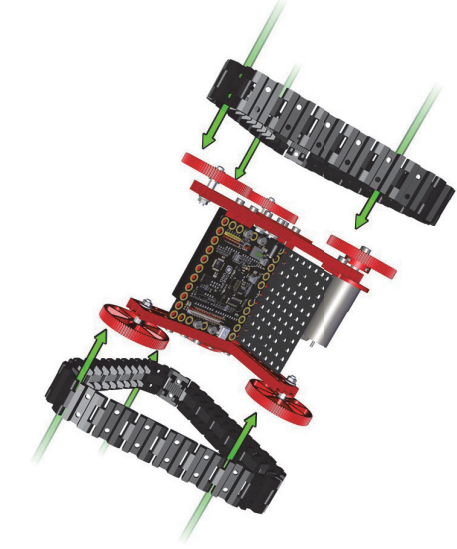
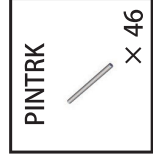

# 15

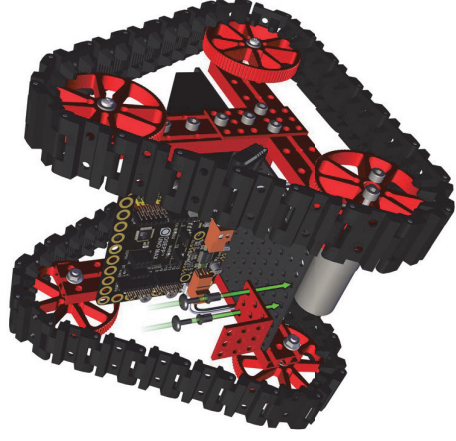
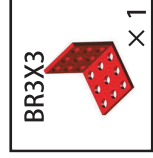

# 14

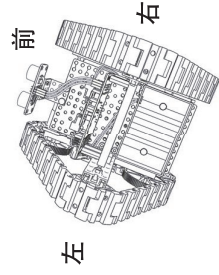
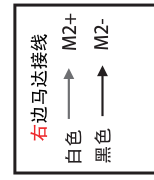
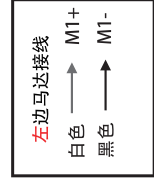
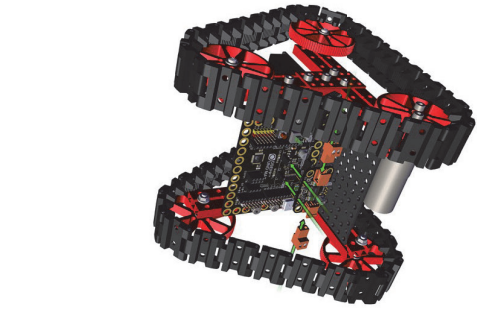
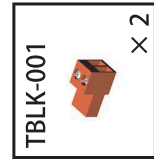
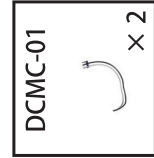
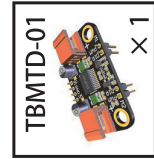

# 16

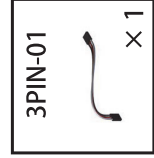

超声波模块连线

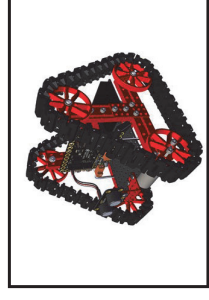
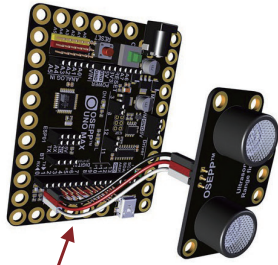
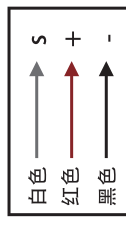

# 配件清单

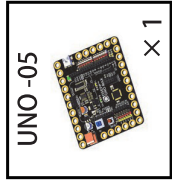

UNO MAX



马达



电池盒

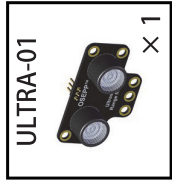

超声波模块

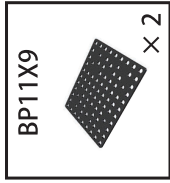

安装底板



马达支架

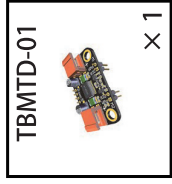

马达驱动模块

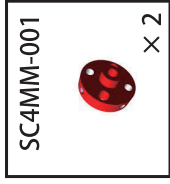

法兰

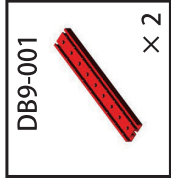

双排梁 9 孔

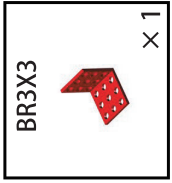

支架

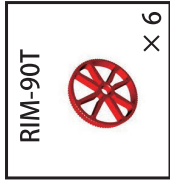

同步带轮

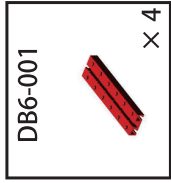

双排梁 6 孔



轴连接器



M4 内六角螺丝



隔离柱

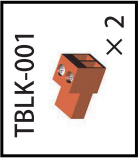

马达接线端子



M3 无头螺丝



M4 内六角螺丝

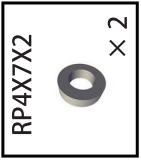

尼龙垫圈

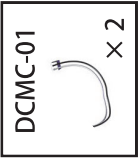

马达连接线

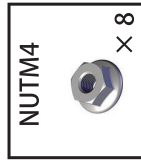

M4 法兰螺母



M4 内六角螺丝

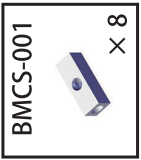

梁连接器

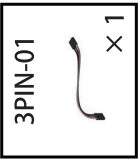

超声波连接线



法兰轴承



M3 沉头螺丝



履带

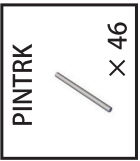

销轴

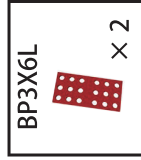

支架

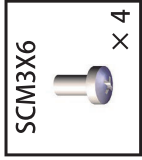

M3 十字螺丝



M4 塑料铆钉